

Tabulated Data
ECP System

Revised February, 2017

*Copyright, U.S.A., Griswold Machine & Engineering
594 Mendon Road, Union City, MI 49094
(800) 248-2054 Fax: (517) 741-7483*

CAUTION

EXCAVATION PROCEDURES MAY CAUSE INJURY OR DEATH!

A COMPETENT PERSON WHO SATISFIES THE DEFINITION AND INTENT OF THE 1926 CONSTRUCTION STANDARD SUBPART P EXCAVATIONS SHALL: ENSURE THAT ALL EMPLOYEES ARE WORKING IN SAFE CONDITIONS AND THAT ALL EMPLOYEES HAVE BEEN TRAINED IN CORRECT EXCAVATION PROCEDURES AND THE PROPER USE OF THE PROTECTIVE EQUIPMENT CHOSEN.

EXCAVATIONS AND PROTECTIVE EQUIPMENT SHALL BE INSPECTED A MINIMUM OF ONCE EACH WORKING DAY AND WHENEVER THERE IS A CHANGE IN THE SOIL CONDITIONS AND/OR OTHER CHANGES SUCH AS AN INCREASE OR DECREASE IN WATER OR VIBRATIONS.

EMPLOYEES SHALL NOT BE ALLOWED TO ENTER AN EXCAVATION THAT IS NOT PROPERLY SHORED, SHIELDED, OR SLOPED.

EMPLOYEES SHALL ALWAYS ENTER, WORK, AND EXIT WITHIN THE SHORED, SHIELDED, OR SLOPED AREAS OF THE EXCAVATION AND/OR TRENCH.

ALL LIFTING AND PULLING EQUIPMENT, INCLUDING CABLES, SLINGS, CHAINS, SHACKLES AND SAFETY HOOKS SHALL BE INSPECTED FOR DAMAGE OR DEFECTS PRIOR TO USE AND SHALL BE EVALUATED FOR SUITABILITY AND CAPACITY.

THIS GME TABULATED DATA PROVIDES A GENERAL SET OF GUIDELINES TO ASSIST THE COMPETENT PERSON IN THE SELECTION OF A PROTECTIVE SYSTEM FOR EMPLOYEE SAFETY. THE RESPONSIBILITY FOR JOB SITE SAFETY AND THE PROPER SELECTION, INSTALLATION AND REMOVAL OF THE SHORING EQUIPMENT BELONGS TO THE COMPETENT PERSON DESIGNATED FOR THAT JOBSITE. THIS TABULATED DATA IS NOT INTENDED TO BE USED AS A JOB SPECIFIC EXCAVATION/TRENCHING SAFETY PLAN, BUT SHALL BE USED BY THE COMPETENT PERSON. TABULATED DATA IS INTENDED AS A SUPPLEMENT TO HIS/HER TRAINING, EXPERIENCE AND KNOWLEDGE OF SAFE PROCEDURES, JOB SITE CONDITIONS AND SOIL TYPES. TABULATED DATA IS INTENDED TO ASSIST HIM IN THE SELECTION OF AN APPROPRIATE PROTECTIVE SYSTEM FOR EMPLOYEE SAFETY.

ECP SYSTEM TABULATED DATA

GENERAL:

1. This data has been prepared by a Registered Professional Engineer as required OSHA standard 29 CRF, Part 1926, Subpart P, Excavations.
2. This data is to be used by the "competent person" for the proper use and **placement** of ECP System components.
3. "Competent person" is one who is capable of identifying existing and predictable hazards in the surroundings or working conditions which are unsanitary, hazardous, or dangerous to employees, and who has authorization to take prompt corrective measures to eliminate them.
4. When there is a discrepancy concerning the use of protective systems between this tabulated data and the OSHA standard, this data shall take precedence. Any topic not covered by this data shall be governed by the OSHA standard.
5. GME shall not be liable for damage or injury resulting from improper use of the ECP System. Improper use of or modifications to the structural components not specifically authorized by GME without the written consent of GME shall void this data and all manufacturer's warranty.

SPECIFICATIONS FOR USE OF THE ECP SYSTEM

1. All personnel involved with the use of ECP System shall be trained in the proper use and installation procedures and other applicable safety requirements.
2. The ECP System shall be used only in soil conditions indicated in this data.
3. Refer to the installation procedures for typical installation figures.
4. The system shall be installed in a manner to prevent lateral movement.
5. The struts shall not be used to support side loading on the struts, nor shall the system be lifted, pulled or moved by the struts. The system shall be installed and extracted by the lifting eyes provided by the manufacturer. Struts are not designed to support vertical loads and shall not be used to provide access or egress to the trench

**ECP
TABULATED DATA**

SPECIFICATIONS FOR USE OF THE ECP SYSTEM CON'T

6. This data is valid for ECP components in structurally sound condition. Any significant damage will void this data, and all manufacturers warranty. The damaged components shall not be used.
 7. When the system is used in a four-sided assembly, a bottom panel may be left out on one side or on two opposite sides.
-

SOIL CLASSIFICATION

1. See the OSHA regulations for descriptions of Type A, B, and C soils.
 2. Type C-60 soil is a soft cohesive or moist granular soil that is not flowing or submerged. This soil can be cut vertically and will stand long enough to safely install the protective system.
-

NOTES FOR TABULATED DATA

1. The top strut of the system shall be no more than twenty-four inches below the top of the trench.
2. The lowest strut of the system shall be no more than the value indicated on the maximum depth tables above the bottom of the excavation. All additional struts shall be spaced at a maximum of thirty-six inches to the top of the excavation.
3. When sectional posts are utilized, a strut shall be placed at each panel joint.
4. Surcharge loads are not included in the maximum depth tables. Surcharge loads are possible due to heavy equipment, vibrations, or soil piles adjacent to the trench. (Adjacent is defined as within a distance equal to the depth of the trench.)
5. If the system is used in a four-sided configuration with different sized panels, the maximum of the excavation shall not exceed the depth rating of the longer panel as indicated in the maximum depth table.
6. All strut components shall have a safe working load of 28,000 lb with a minimum factor of safety of 1.5.

ECP MAXIMUM DEPTH TABLE (1.1)					
PANEL LENGTH	CAPACITY PSF	SOIL TYPE			
		A	B	C-60	C-80
4'	1738	71'	40'	30'	23'
6'	1189	49'	27'	21'	16'
8'	903	37'	21'	16'	12'
10'	728	30'	17'	13'	10'
12'	610	25'	15'	11'	9'
14'	416	18'	10'	8'	6'
16'	420	18'	10'	8'	6'

VERTICAL MEMBER = 2 WAY CORNER POST
 MAXIMUM VERTICAL PIPE CLEARANCE = 36 INCHES

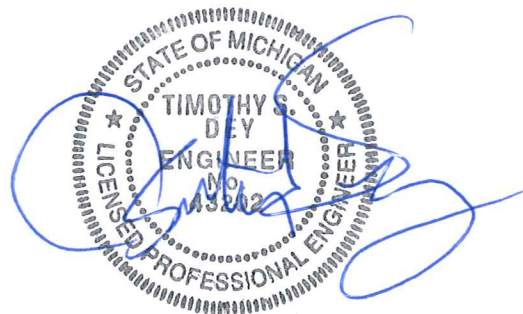
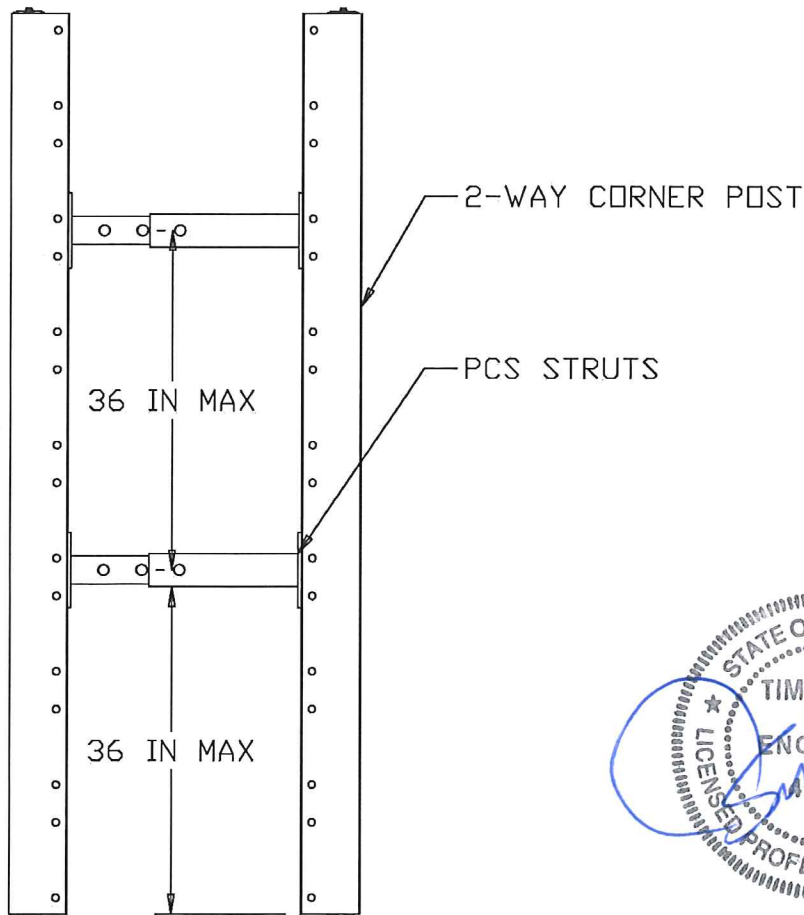

ECP MAXIMUM DEPTH TABLE (1.2)					
PANEL LENGTH	CAPACITY PSF	SOIL TYPE			
		A	B	C-60	C-80
4'	3629	99'	82'	61'	46'
6'	2483	99'	56'	42'	32'
8'	1505	61'	34'	26'	20'
10'	979	40'	23'	17'	13'
12'	653	27'	16'	12'	9'
14'	416	18'	10'	8'	6'
16'	420	18'	10'	8'	6'

VERTICAL MEMBER = 2 WAY CORNER POST
 MAXIMUM VERTICAL PIPE CLEARANCE = 24 INCHES

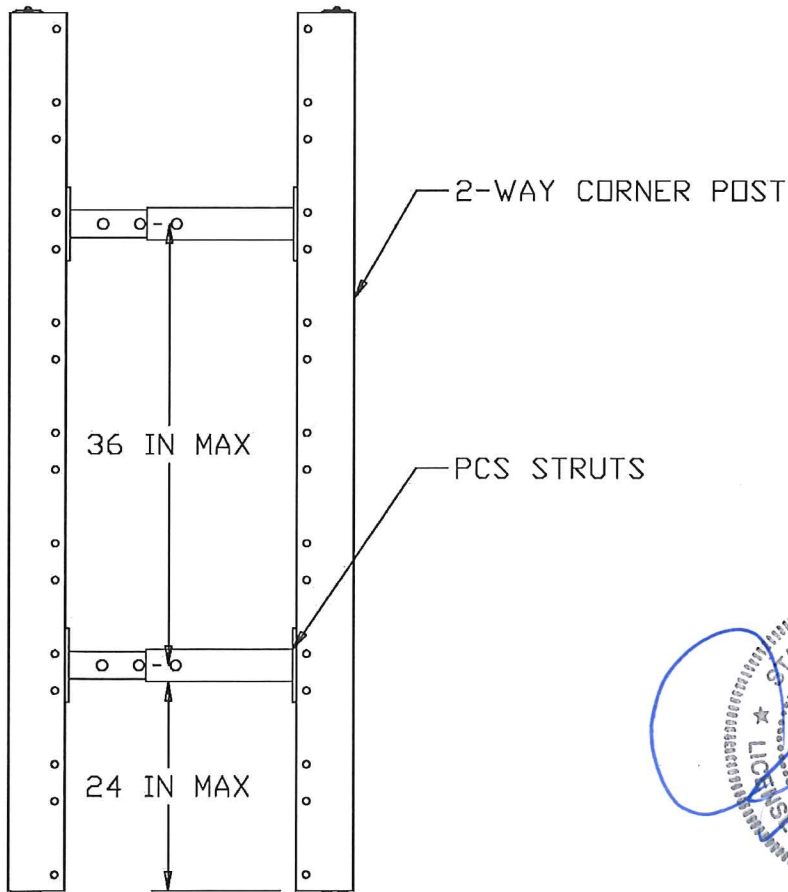

2-Sided Assembly Instructions For ECP Modular Trench Shields

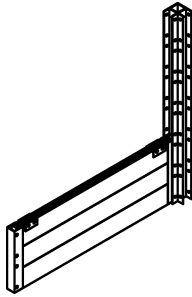

1. Corner post is attached to panel. Install pins with handle on the outside. Ensuring that all matching holes have a pin and keeper.

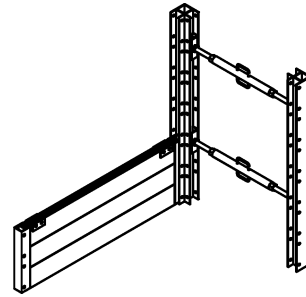

2. Set back spreaders at required spacing (refer to tabulated data) and 2nd corner post. Install pins and keepers in all matching holes.

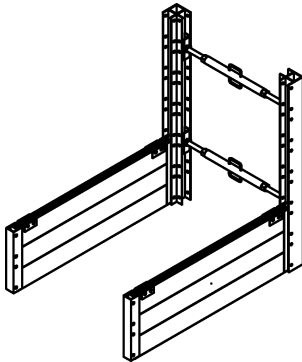

3. Place panel on 2nd corner.

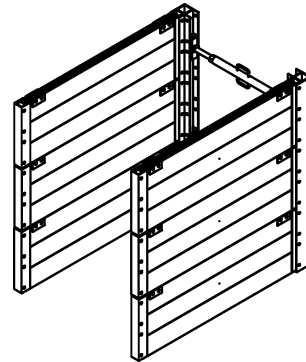

4. Install factory approved lift eyes, then install the remaining panels to desired height ensuring that all matching holes have a pin and keeper.

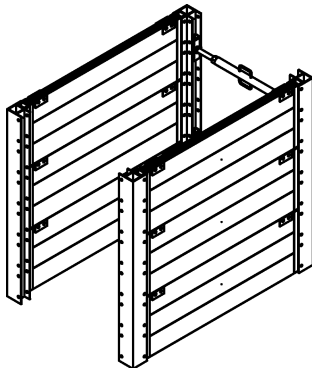

5. Add 3rd and 4th corner post ensuring that all matching holes have a pin and keeper. Install remaining lift eyes.

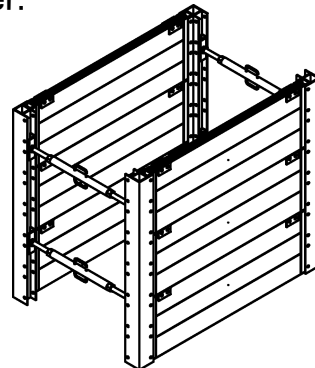

6. Install spreaders at required locations (refer to tabulated data). All matching holes require a pin and keeper.

For Disassembly: Do above steps in reverse order. Remove pins & keepers from one spreader, post, or panel at a time. **DO NOT REMOVE ALL PINS & KEEPERS AT ONE TIME.**

NOTES :

1. Assemble on level ground.
2. Lift with factory supplied lift eyes.
3. All matching holes must have a pin and keeper.
4. System must be used in accordance to manufactures tabulated data.
5. Bottom panel may be omitted, allowing 2 feet open, only if there is no possible loss of soil from behind or below the bottom of the shield.

3-Sided Assembly Instruction For ECP Modular Trench Shields

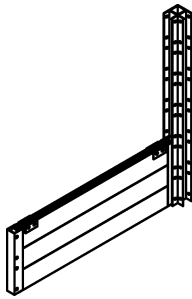

1. Corner post is attached to panel. Install pins with handle on the outside. Ensuring that all matching holes have a pin and keeper.

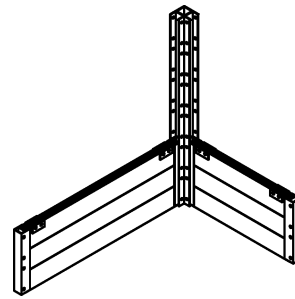

2. Set back panel for 3 or 4 sided system. Install all pins and keepers in all matching holes.

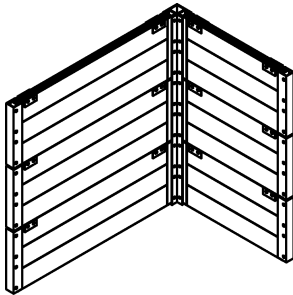

3. Stack panels to desired height before adding 2nd corner post.

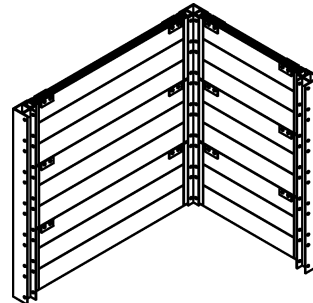

4. Install factory approved lift eyes, then install 2nd and 3rd corner post. Ensuring that all matching holes have a pin and keeper.

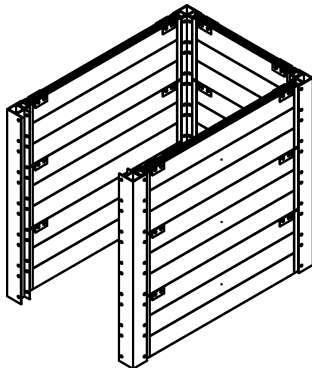

5. Add opposite panels to desired height. Add 4th corner post. Ensuring that all matching holes have a pin and keeper. Install remaining lift eyes.

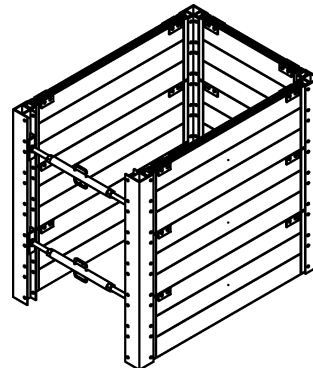

6. Install spreaders at required locations (refer to tabulated data). All matching holes require a pin and keeper.

For Disassembly: Do above steps in reverse order. Remove pins & keepers from one spreader, post, or panel at a time. **DO NOT REMOVE ALL PINS & KEEPERS AT ONE TIME.**

NOTES :

1. Assemble on level ground.
2. Lift with factory supplied lift eyes.
3. All matching holes must have a pin and keeper.
4. System must be used in accordance to manufactures tabulated data.
5. Bottom panel may be omitted, allowing 2 feet open, only if there is no possible loss of soil from behind or below the bottom of the shield.

4-Sided Assembly Instructions For ECP Modular Aluminum Shields

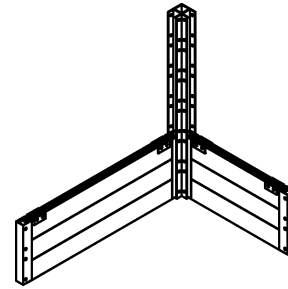
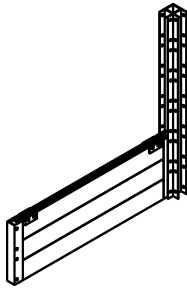

1. Corner post is attached to panel. Install pins with handle on the outside. Ensuring that all matching holes have a pin and keeper.

2. Set back panel for 3 or 4 sided system. Install pins and keepers all matching holes.

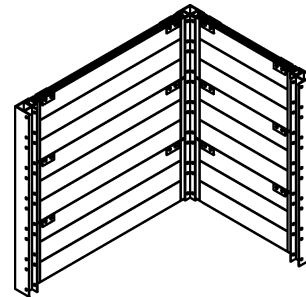
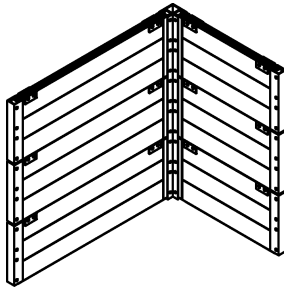

3. Stack panels to desired height before adding 2nd corner post.

4. Install factory approved lift eyes, then install 2nd and 3rd corner post. Ensuring that all matching holes have a pin and keeper.

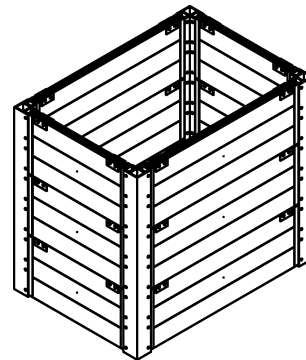
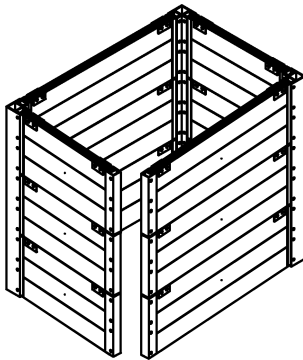

5. Add opposite panels to desired height. All matching holes require a pin and keeper. Install remaining lift eyes.

6. The 4th corner post can then be slid into place, A prybar may be needed to align post with holes. All matching holes require a pin and keeper.

For Disassembly: Do above steps in reverse order. Remove pins & keepers from one spreader, post, or panel at a time. **DO NOT REMOVE ALL PINS & KEEPERS AT ONE TIME.**

NOTES :

1. Assemble on level ground.
2. Lift with factory supplied lift eyes.
3. All matching holes must have a pin and keeper.
4. System must be used in accordance to manufactures tabulated data.
5. Bottom panel may be omitted, allowing 2 feet open, only if there is no possible loss of soil from behind or below the bottom of the shield.